



ISSUE 04

# INSTALLATION, OPERATION AND MAINTENANCE INSTRUCTIONS

## Protecta III Stainless Steel (Bi pin) Luminaire

### *ATEX & IECEX*

**Important:** Please read the following instructions carefully prior to installation or maintenance of this equipment.

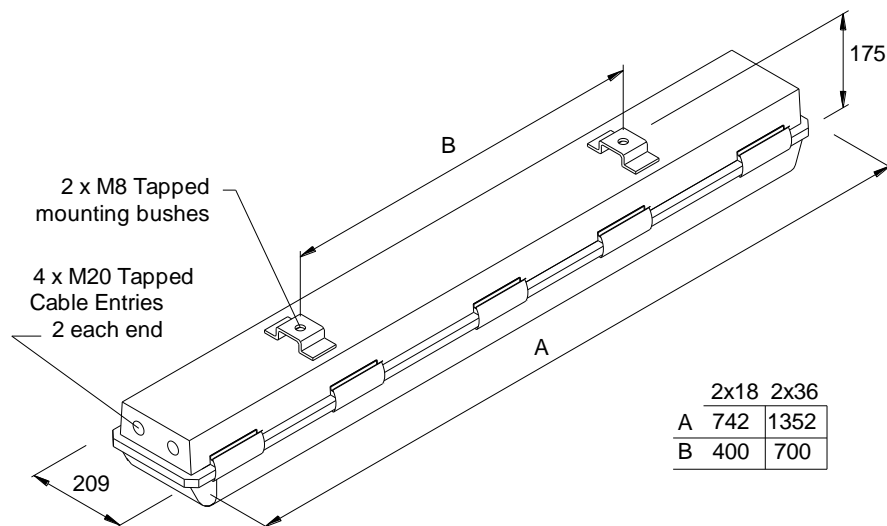



Type Of Protection	Bi Pin with Ex d switch	Ex e mb q (Increased safety, Encapsulation, Powder filling), Ex tb (dust). Ex d e mb q
Protection Standards	(IEC) EN 60079-0, (IEC) EN 60079-1, (IEC) EN 60079-5, ((IEC) EN 60079-7, (IEC) EN 60079-18, (IEC) EN 61241-1	
Area Classification	Zone 1 and Zone 2 areas to (IEC) EN 60079-10-1 Zone 21 and Zone 22 areas to (IEC) EN 60079-10-2	
Installation	(IEC) EN 60079-14	
Certificate	IEC certificate of conformity IECEx BAS 09.0017 EC type examination certificate Baseefa04ATEX0220	
Equipment Coding	Ex e mb q IIC T4 Gb or Ex d e mb q IIC T4 Gb Ex tb IIIC T85°C Db IP6X -20°C ≤ Ta ≤ +55°C	
ATEX Coding	Ⓔ II 2GD	
Ingress Protection	IP66/67 to EN(IEC) 60529	
CE Mark 	<p>The CE marking of this product applies to "The Electrical Equipment (Safety) Regulations 2006", "The Electromagnetic Compatibility Regulations 2004", the "Waste Electrical and Electronic Equipment Regulations 2006" and the "Equipment and Protective Systems intended for use in Explosive Atmospheres Regulations 1996". [This legislation is the equivalent in UK law of EU directives 2014/35/EU, 2014/30/EU, 2012/19/EU and 2014/34/EU respectively].</p> <p>The Equipment is declared to meet the provisions of the ATEX directive (2014/34/EU) by reason of the EC Type Examination and compliance with the Essential Health and Safety Requirements. M Poutney Technical Manager</p>	

### 1.0 Introduction – Protecta Stainless Steel ATEX and IECEx with EOL Protection

This installation leaflet covers the range of ATEX and IECEx Protecta Stainless Steel luminaire models with the Ex q control gear which has EOL circuitry and electronic safety sensor. These luminaires are mainly used in harsh environments and are constructed using a corrosion resistant glass reinforced polyester body and polycarbonate diffuser. Refer to the current catalogue for information on product references. The range is available for use with T8 bi-pin lamps to IEC81. The appropriate lamp cap should be specified when ordering. The luminaires are available in 2 x 18W and 2 x 36W sizes.

### 2.0 Electrical Supplies

Lamps	2 x 18W	2 x 36W
Voltage range AC	110-130V or 220-254V	
Voltage range DC	110-150V or 220-300V	
Frequency range Hz	47-63Hz	
Power Watts 220-254V	35W	70W
Current Amps 220-254V	0.17A	0.32A
Power Watts 110-130V	35W	70W
Current Amps 110-130V	0.34A	0.65A

The safety limit for surface temperature (T rating) is +/-10% on the rated voltage. Equipment should not be operated continuously at more than +10/-10% of the rated voltage of the control gear.

#### Power Factor >0.98

Power is constant over voltage range.

#### Over voltage

400V ac for 1 min and EN 61000-4-5 > 4kV

#### Through Wiring

The through current rating is 16A. 4mm<sup>2</sup> terminals are standard (6mm<sup>2</sup> wiring can be used in the terminals in accordance with the luminaire certificate).

#### Storage

Luminaires are to be stored in cool dry conditions preventing ingress of moisture and condensation. Storage temperature range to be -40°C to +80°C.

#### Lamps

The lamps used in the range can be T8 bi-pin fluorescent with G13 cap. Lamp caps are to IEC 60061, lamp dimensions and safety to IEC 61195 and lamp performance to IEC



60081. Please note that this luminaire is suitable for IEC lamps only. Do not use American specification lamps.

### Fuse and MCB Ratings

It is recommended that for selection of MCBs users should consult the MCB manufacturer as this unit contains electronic control gear. The electronic control gear has nominal values of inrush current of 30A for 500µs on 230V and 45A for 350µs on 110V.

### EOL Circuitry

The Protecta III control gear has circuitry to protect against the potential effects from the end of life condition associated with fluorescent lamps in accordance with IEC 61347-2-3 and 60079-7.

Typical wiring diagram shown for information only, some models may differ.

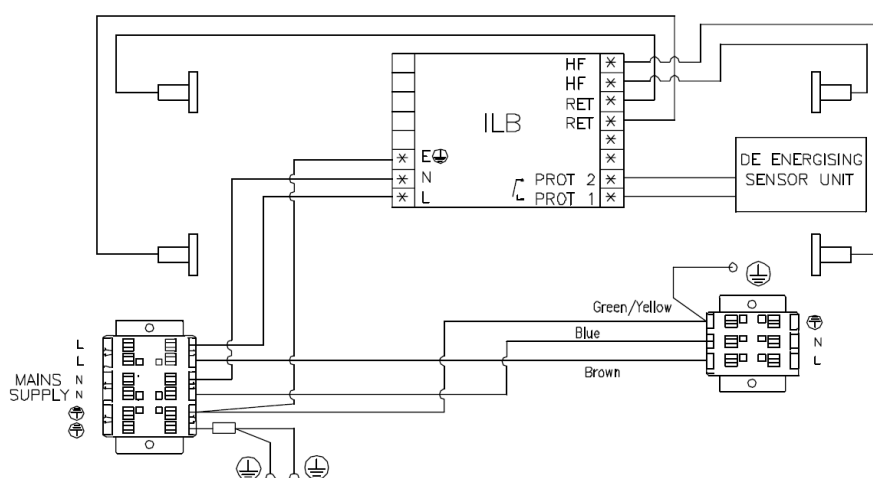

## 3.0 Installation and Safety

### 3.1 General

**These instructions should be read fully and carefully before attempting to install the luminaire. For details of servicing operations, opening etc. see section 4.0.**

Copies of these instructions should be held in a safe place for future reference. It is the responsibility of the installer to ensure that the apparatus selected is fit for its intended purpose and that the installation, operation and maintenance of the apparatus complies with applicable regulations, standards or codes of practice.

Installation should be carried out in accordance with *EN 60079-14* or with a local hazardous area code of practice, whichever is appropriate.

Risk of electrostatic discharge:

- Clean diffuser only with damp cloth
- Avoid mounting near fast moving streams of air

Any specific installation instructions must be referred to. In the UK the requirements of the *Health and Safety at Work Act* must be met and electrical work associated with this product must be in accordance with the "*Manual Handling Operations Regulations*" and "*Electricity at Works Regulations 1989*". Disposal instructions should be complied with.

The luminaires should be considered Class 1 to EN 60598 and effectively earthed.

Certification details on the rating plate must be verified against the application requirements before installation.

The information in this leaflet is correct at the time of publication. The company reserves the right to make specification changes as required without notice.

#### 3.1.1 Use in Combustible Dust Atmospheres

- De-rating of the surface temperature will be required where dust clouds may be present
- Do not allow dust to accumulate in layers
- Dust in layers has the potential to form ignitable clouds and to burn at lower temperatures
- Refer to EN (IEC) 60079-10-2 & EN (IEC) 60079-14 for additional details of selection and installation.



### 3.2 Tools

3mm and 4mm flat blade screwdriver and large crosshead screwdriver. Suitable spanners for installing cable glands. Pliers, knife, wire strippers/cutters.

### 3.4 Lamps

The lamps will run until they are worn out. New lamps should be fitted in pairs even if one appears to be still working. If the result is not satisfactory, check continuity to the ballast. If still no result, check the continuity to the lampholders after disconnecting leads from ballast. If no fault found replace ballast. If still no result, disconnect the connection to the sensor. If the lamps light this would indicate a faulty sensor, see 6.9, but as this is most unlikely, check all connections before replacing.

### 3.5 Mounting

Luminaires should be installed where access for maintenance is practical and in accordance with lighting design information. For horizontal mounting on handrails Chalmit recommend mounting the luminaire with the clamps uppermost therefore allowing the diffuser and gear tray to swing down when necessary. Refer to the note in 3.1 concerning electrostatic charge. The standard suspension is via two M8 stainless steel bushes. Various adaptors, pole clamps and suspension brackets are available to order.

### 3.6 Cabling and Cable Glands

The temperature conditions at the supply cable entry point are such that 70°C (ordinary PVC) cable can be used. . Equipment certified cable glands and sealing plugs must have suitable IECEx/ATEX approval. When installed the cable gland or sealing plug should maintain the IP rating of the enclosure, however as a minimum a rating of IP64 must be maintained. When a cable gland or sealing plug is installed which reduces the marked IP rating of the enclosure the end user must ensure this is suitably documented.

Four entries are provided. Three entries are fitted with suitably approved blanking plugs, the fourth entry with a transit plug. M20 x 1.5 entries are standard, other sizes are available on request. The standard entry configuration is with an earthed metal plate with tapped holes mounted in the body.

### 3.7 Electrical Connections and Testing

If work other than re-lamping is to be done on any luminaire already connected to the electrical system, the luminaire must be isolated from the system.

The diffuser cover is swung down and removed, if necessary, by swivelling back as far as possible then lifting off. To access the mains terminals loosen the four fixing screws, slide the reflector/gear tray over the slots and swing the reflector/gear tray down. Luminaires are supplied suitable for looping and through wiring. Screw type or screw-less "cage clamp" terminals are fitted in the range of luminaires. Mains terminal blocks are marked L N Earth.

Luminaires can also be supplied with three phase wiring to special order. The marking is L1 L2 L3 N Earth

The maximum amount of insulation allowed beyond the throat of the terminal is 1mm. The normal method of insulation testing is to connect Live and Neutral together and test between this point and Earth to prevent the risk of damage to the electronic control gear. However, if this is not possible luminaires can be tested with an insulation tester that complies with IEC 364 or BS 7671 with a maximum output current of 1mA and output voltage of 500V dc. (Units damaged by incorrect insulation testing can be detected).

Before completing the wiring, ensure that all the connections are correctly introduced into place before reassembling the luminaire. New lamps should be fitted.

### 4.0 Servicing and Operation

The bi-pin luminaire incorporates an electronic safety de-energiser for maximum reliability. The electronic sensor is operated by the actuating plate on the diffuser. This provides for the safe opening and carrying out of re-lamping.

***Safe servicing behind the gear tray requires the mains supply to be isolated.***

#### 4.1 Opening and Closing the Cover

The procedure for opening the diffuser on the Stainless Steel models is as follows:

Insert the tool under the stainless steel clamp with the end of the tool located, a wide blade screwdriver is recommended. Gently lever the tool upwards towards the diffuser and the clamp will begin to open. Repeat the procedure for all the clamps. The integral hinge will retain the cover.

The procedure for closing and securing the cover is as follows:

Ensure the hinge mechanism is clear of any obstruction and then swing the diffuser into the closed position. Support the diffuser in position whilst pushing each of the clamps over the edge of the diffuser.

#### 4.2 Fitting lamps and Re-Lamping

**IMPORTANT** - If the luminaire is maintained with the power on, the lamps will go out when the cover is opened. If this does not happen there is a fault. Do not remove the lamps. The control gear will be damaged if the lamps are removed without being de-energised and there is an ignition risk. This could occur if the sensor arrangement is faulty or has been defeated. The luminaire must be de-energised the control gear checked and electronic sensor assembly must be replaced if faulty, see 6.9.

**Lamps which are not operating or appear dim should be replaced as soon as practical.** The control gear is designed to withstand end of life conditions of lamps. Always replace both lamps.



The bi-pin lamps are fitted in lampholders with a rotating section. The lamp must be pushed firmly down into the lampholder and rotated 90°. The contact is biased to remain in the 90° position. If the lamp does not rotate, check that it is completely positioned into the lampholder. Before inserting bi-pin lamps ensure the lamp pins are not damaged or slack in the end cap.

#### 4.3 Releasing the Reflector/Gear Tray

Loosen the four fixing screws retaining the reflector/gear tray far enough for it to slide over keyhole slots. The tray will hang on the retaining cords without stressing the wiring between body and tray. Replace in reverse order.

#### 4.4 Removal of Reflector/Gear Tray

Release gear tray from body and hang on retaining cords, as explained above. Disconnect the cables from the gear tray to the mains terminal block, unhook retaining cord from gear tray and lift clear. With disconnection made at the screw-less terminals the luminaire is safe when re-closed without the tray.

#### 4.5 Servicing Behind the Gear Tray

**The release of the gear tray exposes live mains terminals. Any work behind the gear tray requires that the supply is isolated to avoid ignition risk and damage to components.**

#### 4.6 Replacement of Ballast

The ballast contains no serviceable parts. Should it be found necessary to replace the ballast, the following procedure should be adopted:

Ensure that the luminaire is isolated from the mains supply.

Remove gear tray from body and swing down as previously explained. Remove the ballast from the tray. Ballasts use locking tab connectors which are released when the black cover sleeve is pulled away axially. When replaced a 'click' will be heard as the lock locates. **On no account should the quick release connectors be replaced with proprietary items.**

Disconnect the leads to the ballast, note the connections.

#### 4.7 Replacement of Micro Switch if fitted

Before carrying out any work ensure that the unit is isolated from the mains. Identify the four micro switch wires and disconnect from the terminal block. Free the leads from the retaining connections, remove the two screws holding the switch in position. Replace the micro switch and reconnect. Check the connections and terminal polarity against either a circuit diagram or a note made prior to dismantling. A complete new assembly including the connecting receptacles for the model must be used.

#### 4.8 Replacement of sensor

It is very unlikely that this assembly will need replacement other than as a result of mechanical damage.

Isolate the mains. Disconnect the sensor and note the connections. Undo the two screws and replace the unit using the nuts from the old unit. Reconnect and carefully check the connections before re-energising.

#### 5.0 Routine Maintenance

Visual tests and checks should be carried out at intervals described by the appropriate regulations, EN 60079-17, and should include the following:

Check that the lamps are working or appear badly aged. Blackening at the lamp ends is a good indication of ageing.

- Check for mechanical damage/corrosion.
- Check connections, fixings, glands and plugs.
- Check for undue accumulations of dust, dirt or moisture.
- Check for unauthorised modifications.

Periodic inspection of the enclosure seal should be carried out to ensure that the seal is sound. The seal can be replaced and, if necessary, secured in position by the application of a **very** small amount of rubber adhesive and using the joining piece. If the luminaire has been subject to abnormal conditions, for example, severe mechanical impact or chemical spillage, it must be de-energised until it has been inspected by an authorised and competent person

#### 5.1 Cleaning

The body of the luminaire may be cleaned with a mild solution of household detergent and water, after cleaning the body should be washed and wiped with clean water. **The diffuser should not be polished or wiped with a dry cloth as a risk of ignition due to electrostatic discharge may result.** Cleaning of the diffuser with any chemical or hydrocarbon solvent based cleaner may result in severe damage.

#### 6.0 Disposal of Material

##### General

Disposal of the luminaire as waste should be carried out in accordance with national regulations. Any disposal must satisfy the requirements of the [WEEE directive \[2012/19/EU\]](#) and therefore must not be treated as commercial waste. The unit is mainly made from incombustible materials. The control gear contains plastic, resin and electronic components. All electrical components may give off noxious fumes if incinerated.





### 6.1 Lamps

Fluorescent lamps in modest quantities are not "special waste". They should be broken up in a container to avoid injury, avoid inhaling dust. **Important:** *Do not incinerate lamps.*



To comply with the Waste Electrical and Electronic Equipment directive 2012/19/EU the apparatus cannot be classified as commercial waste and as such must be disposed of or recycled in such a manner as to reduce the environmental impact.



Chalmit Lighting is a leading supplier of Hazardous Area lighting products

	<p><b>CHALMIT LIGHTING</b> PO Box 5575 Glasgow, G52 9AP Scotland</p>	
<p>Telephone: +44 (0) 141 882 5555 Fax: +44 (0) 141 883 3704 Email: <a href="mailto:info@chalmit.com">info@chalmit.com</a> Web: <a href="http://www.chalmit.com">www.chalmit.com</a></p>	<p>Registered No: 669157 Registered Office: Cannon Place 78 Cannon Street London EC4N 6AF UK</p>	

For technical support, please contact: [techsupport@chalmit.com](mailto:techsupport@chalmit.com)

Note: Chalmit Lighting reserves the right to amend characteristics of our products and all data is for guidance only.



 <b>EU-Declaration of conformity</b> <b>UE-Déclaration de conformité</b> <b>EU-Konformitätserklärung</b>			
Manufacturer	Chalmit	Address	388 Hillington Road, Glasgow. G52 4BL Scotland UK
Product	Protecta III Stainless Steel Fluorescent Luminaire (Bi Pin)		
EC - Type Examination Certificate	Baseefa04ATEX0220		
Notified Body	Baseefa 1180		
ATEX Coding	 II 2 GD	ATEX Classification	Group II Category 2 GD
Equipment Coding	Ex e mb q IIC T4 Gb, Ex tb IIIC T85°C Db or Ex d e q IIC T4 Gb, Ex tb IIIC T85°C Db IP6X -20°C ≤ Ta ≤ +55°C		
Ingress Protection	IP66/67		
The technical basis, with respect to equivalence of			
La base technique, en ce qui concerne l'équivalence de			
Die technische Grundlage hinsichtlich der Normen			
Protection Standards EN 60079-0, EN 60079-1, EN 60079-5, EN 60079-7, EN 60079-18, EN 61241-1			
Area Classification EN 60079-10-1 and EN 60079-10-2			
of compliance with the EHSRs is valid as there are no changes which materially affect the state of technological progress of the product.			
en conformité avec les EESS est valide puisqu'il n'y a aucun changement qui affecte matériellement l'état de l'évolution technologique du produit.			
zur Erfüllung der GSGA ist gegeben, da keine Änderungen erfolgt sind, die einen Einfluss auf den technischen Stand des Produkts haben.			
Terms of the directive:		Standard & Date Certified to	Standards Date Declared to
Prescription de la directive:		Standard & date certifiée à	Normes date Déclaré
Bestimmungen der Richtlinie:		Standard & Datum Zertifiziert nach	Standards Datum erklärt
2014/34/EU	Equipment and protective systems intended for use in potentially explosive atmospheres.	EN 60079-0 : 2009	2012
		EN 60079-1 : 2007	2014
2014/34/UE	Appareils et les systèmes de protection destinés à être utilisés en atmosphères potentiellement explosibles.	EN 60079-5 : 2007	2015
		EN 60079-7 : 2007	2015
2014/34/EU	Geräte und Schutzsysteme zur bestimmungsgemäßen Verwendung in explosionsfähigen Bereichen.	EN 60079-18 : 2004	2015
		EN 61241 : 2004	EN 60079-31 : 2014
2014/30/EU	Electromagnetic compatibility	EN 55015 : 2013	
2014/30/UE	Compatibilité électromagnétique	EN 61547 : 2009	
2014/30/EU	Elektromagnetische Verträglichkeit	EN 61000-3-2 : 2014	
2014/35/EU	Low voltage equipment	EN 60598-1 : 2015	
2014/35/UE	Équipements électriques à bas voltage	EN 60529 : 1992	
2014/35/EU	Niederspannungsgeräte / -systeme		
2012/19/EU	Waste of electrical and electronic equipment	Shell Deluge DTS-01 : 1991	
2012/19/UE	Déchets d'équipements électriques et électroniques	Seismic EN 60068-3-3 : 1993	
2012/19/EU	Entsorgung der elektrischen und elektronischen Geräte / Systeme	Nuclear Seismic IEC 60980-6 : 1993	
2011/65/EU	RoHS II Directive		
Additional information:	The luminaire is capable of withstanding over voltage levels of up to 400V AC for 1 minute and impulse voltage surges of 4kV.		
Informations complémentaires:	Le luminaire peut supporter des niveaux de tensions jusqu'à 400V CA pendant 1 minute et des tensions de choc de 4kV.		
Zusatzinformation	Dieser Strahler widersteht Überspannungen bis 400V AC 1 Minute lang sowie Stoßspannungen von 4kV.		



:

On behalf of the Chalmit, I declare that, on the date the equipment accompanied by this declaration is placed on the market, the equipment conforms to all technical and regulatory requirements of the above listed directives.

En tant que représentant du fabricant Chalmit, je déclare qu'à la date où les équipements accompagnant cette déclaration sont mis sur le marché, ceux-ci sont conformes à toutes les dispositions réglementaires et techniques des directives énumérées ci-dessus.

Hiermit bestätige ich, im Namen von Chalmit, dass am Tag der Lieferung des Produkts/der Produkte zusammen mit dieser Erklärung das Gerät/die Geräte alle technischen und regulativen Anforderungen der oben aufgeführten Direktiven erfüllt.

Name and Date	Mark Poutney	04/02/2016	Technical Manager	
Nom et Date			Directeur technique	
Name und Datum			Technischer Leiter	
Quality Assurance Notification by:	<b>Baseefa Ltd.</b>	Quality Management System Accreditation:	<b>ISO 9001</b>	
Notification d'assurance qualité par:	<b>1180</b>	Certification du système de gestion de la qualité:	by/par/durch	
Qualitätssicherungsnotifikation durch:		Qualitätsmanagementsystem Akkreditierung:	<b>Loyd's Register</b>	
		<b>Certificate No./Certificat N°/Zertifikat Nr.</b>	<b>LRQ 4005876</b>	